



GUIDE TO PIZZA EQUIPMENT



Things to Consider



CONTAINERS

What containers do you use?
(i.e. pizza boxes, pizza pans, dough boxes,
sheet trays, to-go containers)
Pizza box sizes vary, provide factory
with sample to ensure perfect fit.



WORKFLOW

Pass-thru design is available for a
seamless workflow. Place warmers
between the kitchen and POS; and
place a dough proofer between
the prep and cooking areas.



ACCESS FREQUENCY

How often is product
pulled or reloaded?

Adding Dutch doors can
help curb heat loss.



CAPACITY

What is the max capacity needed
at once during peak volume?

We offer various sizes to fit your
kitchen space and capacity.

CUSTOMER TESTIMONIAL



PEACE LOVE & PIZZA LOVES FWE'S HEATED HOLDING SHELVES

We love our FWE heated holding shelves. They keep our food hot, but don't project heat out and impact the temperature of our store. The team at FWE also custom designed our shelves to fit into our specs. We highly recommend using FWE for your restaurant equipment needs!

RICH DESANTIS / OWNER





Pizza Holding Cabinets

Hold all of your pizzas and sides.



Humi-Temp Heat System

Filling the water pan adds low-level humidity. The additional moisture increases hold times. Includes temperature set range of 90°-190°F.

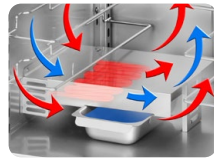

"TS-1633" SERIES

DOUBLE DEEP

Hold lots of pizzas in a small footprint.

Hold Larger Boxes and Sides with Fixed Rack

- ✓ Holds Pizzas Double Deep
- ✓ Humi-Temp Heat System
- ✓ Extra Large Hold XL Pizza Boxes or Pans **16" - 18.5"** or 18" x 26" Sheet Trays
- ✓ Adjustable Shelves To Hold Smaller Items (Extra Shelves Available)
- ✓ Quick Ship Model Available Model TS-1633-36 Is Available for Quick Shipment 🚚

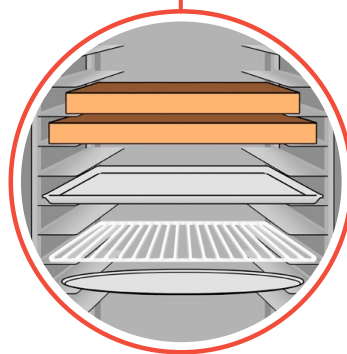

Hold More Box Sizes with Adjustable Slides

- ✓ Holds Pizzas Double Deep
- ✓ Humi-Temp Heat System
- ✓ Small to Extra Large Hold Stacks of Small to Extra-Large Pizza Boxes or Pans **8" - 17"**
- ✓ Stack Orders Slides Can Be Spaced Out as Needed to Stack Boxes

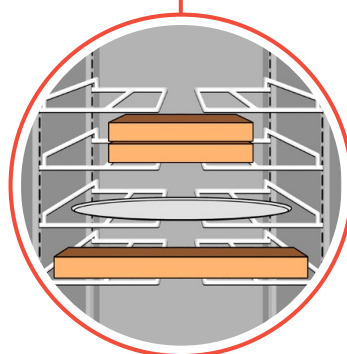

"UHS" SERIES

UNIVERSAL

Need to hold GN pans too? Look at this.

Universal Adjustable Slides Hold Trays, GN Pans, and XL Pizza Boxes

- ✓ Holds Pizzas Single Deep
- ✓ Humi-Temp Heat System
- ✓ Extra Large Hold XL Pizza Boxes or Pans **16.25" - 19.5"**
- ✓ Packaged Sides Holds 18" x 26" Trays, Perfect for Packaged Items
- ✓ Unpackaged Sides Hold Pastas, Sandwiches, Brownies etc. in Various Size Trays, Pans, and Gastro-Norm
- ✓ Quick Ship Model Available Model UHS-12 Is Available for Quick Shipment 🚚



Grab n Go Holding

Easy to see, easy to access.



Radiant Heat System

Heat gently radiates from the heating element. Low-maintenance system has no moving parts. Includes temperature set range of 90°-190°F.

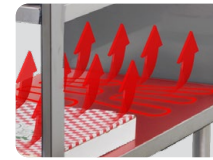

"HHS" SERIES

HEATED SHELVES

Keeps orders warm and easy to take.

The Best Landing Zone for To-Go and Delivery Orders



Hidden Adjustable Thermostat

Remove Panel to Adjust Set Range of 90°-190°F (Factory Set to 175°F)



- ✓ Heats Up Quickly Reaches 175°F in Less than 15 Mins
- ✓ Evenly Heated Shelves Heat Radiates up from Each Shelf (Including the Top)
- ✓ Quick Ship Model Available Model HHS-513-2039 Is Available for Quick Shipment 🚚

HIGHLY CUSTOMIZABLE

Let's design the perfect heated shelf for you and your kitchen! Discover more heated shelf options on the back cover.



Easily Customize Shelf Dimensions and Spacing to Fit Your Operation

Model Shown with Powder Coat Option

"HLC-1717" SERIES

DISPLAY CABINETS

See your food in this countertop cabinet.

Visibly Hold Pizza and More on Adjustable 17.25" Wire Shelves



- ✓ Hold Pizzas and Sides Hold Pizzas, Pastas, Breads, Sandwiches, Brownies etc.
- ✓ See-Thru Door See and Inventory Your Product
- ✓ Adjustable Shelves Adjust Shelves for Your Ideal Spacing
- ✓ Temperature Set Range of 90°-190°F



Dough Prep

Streamline the make line.

"RD" SERIES

DOUGH RETARDER

Slows dough rise and improves flavor.

Slow Rise Develops Complex Flavors During Fermentation

- ✓ Promotes Consistent Rise Gentle Cooled Air Slows Fermentation
- ✓ Temperature Set Range of 33°-70°F Factory Set to 55°F Retarding Temperature
- ✓ Holds 18" x 26" Dough Boxes and 18" x 26" Sheet Trays
- ✓ Stays Cool High Performance Design Enhances Cooling in Hot Kitchens



Ideal for Use with Dough Press



"PHU" SERIES

PROOFER & WARMER

Proofs dough beautifully. Holds food up to 190°F.

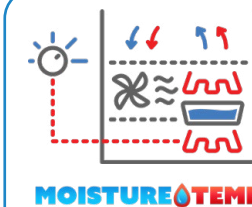

Moisture Temp Heat System

Controls allow you to create high humidity with low heat output – an ideal environment for proofing!

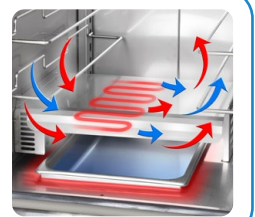

Advanced Proofing for Better Crust

- ✓ Control Moisture & Heat Create the Ideal Air Quality for Perfect Proofing or Extended Heated Holding
- ✓ Low to High Humidity 1-6 Moisture Set Range (Proof Setting of 5)
- ✓ Universal Holding Adjustable Tray Slides Hold Trays, GN Pans, and XL Pizza Boxes **16.25" - 19.5"**
- ✓ Meets Energy Standards Energy Star Certified Models Available
- ✓ Quick Ship Model Available Model PHU-12 Is Available for Quick Shipment 🚚



Extends Hold Times of Cooked Food Products

"PH-BCC" SERIES

"PH-BCC" Includes all of the same features as the "PHU" series proofer / warmer.

- ✓ Built to Support the Weight of a Convection Oven
- ✓ Stacking Equipment Saves Valuable Kitchen Space



Optional Accessories

SOME OPTIONS NOT AVAILABLE ON ALL MODELS



LARGER OR UPGRADED CASTERS



EXTRA TRAY SLIDES

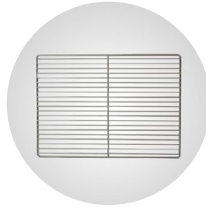

EXTRA SHELF



LEGS WITH FLANGED FEET



CUSTOM SIZING



ENCLOSED ON THREE SIDES



INDIVIDUALLY CONTROLLED SHELVES



POWDER COAT

Holding Fried Side Items?

Keep your wings, mozzarella sticks, and fried sides fresh and crispy with *infrared heat*.



If you can dream it, we can build it.

We can customize our products to meet your space and functionality needs.

Let's talk and explore the possibilities! **1-800-222-4393**



VERSION 001

FOOD WARMING EQUIPMENT COMPANY, INC. | 5599 HIGHWAY 31 WEST • PORTLAND, TN 37148

sales@fwe.com | 800-222-4393 | www.fwe.com